

Excellence in seaming



**8320**

Programmable hot-wedge  
or hot-air welding machine

# PFAFF 8320

The one and only with 100% parameter control

With the new PFAFF 8320 sealing sequences can be programmed, i.e. depending on the cutting and the fabric any parameters can be entered for any given segment and reproduced with 100% accuracy.  
An absolute innovation from PFAFF!

## Features:

- Interchangeable swivel unit - easy exchange from hot air to hot wedge or vice versa.
- Differential transport possible during sealing.
- No buttons, no pressure gauges: One touch screen and 100% parameter control.
- All parameters are controlled electronically:  
One integrated control board monitors the heat-sealing temperature, the air flow, the roller pressure and the two motors for the top and bottom roller.
- Proportional valves enable the dynamic adjustment of the air flow and roller pressure.
- Two precision-controlled motors permit an extremely accurate differential transport.
- 2-axis swing in mechanism:  
The nozzle or wedge can be very accurately adjusted without tools by using a compound slide rest.
- Hinged post: The bottom post holder can be turned over 180° as desired.  
Depending on the application it is possible to feed off the arm, as post- or feed on the arm.
- Adjustable stand height: With a crank the working height can be adjusted exactly to suit the application.
- Different wedge sizes + different nozzle sizes and shapes.
- Several operating levels protected by passwords: If desired, the operator can only select certain operating sequences.
- Selectable languages and units of measurement.
- Heat-up and cool-down cycles possible.
- Machine can be integrated in a complete production unit.
- Options:
  - Tubing guide for filter tubes
  - Exhaust unit
  - Tape reel unit for taping operations
  - Double roller-arm with table
  - Hot-wedge or hot-air nozzle on the right-hand side
  - Puller (direct puller or as separate unit)

## Arm versions:

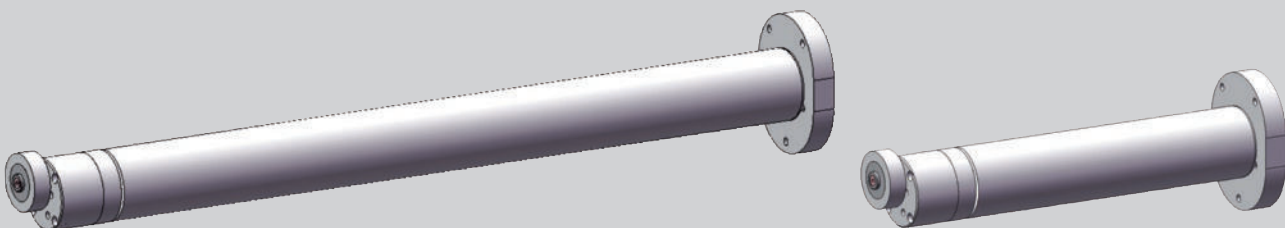

Cylinder post: 470 - 970 mm

## Areas of application PFAFF 8320:

- Car covers
- Flexible tanks
- Keder manufacturing
- Truck awnings
- Swimming pool liners
- Banners
- Small tents
- Inflatable materials
- Convertible tops for cars
- Filter (tubes, pockets, rings)

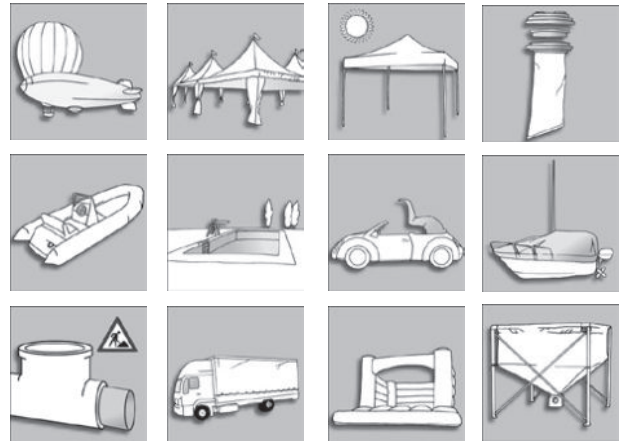

## Optional puller versions

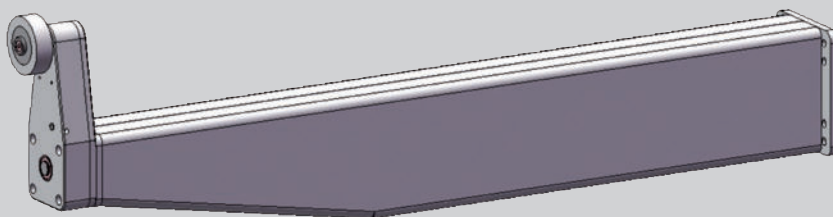
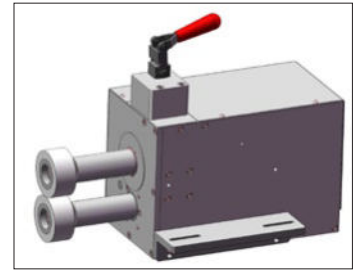
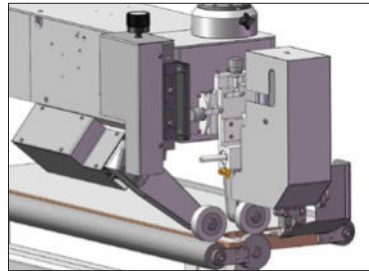
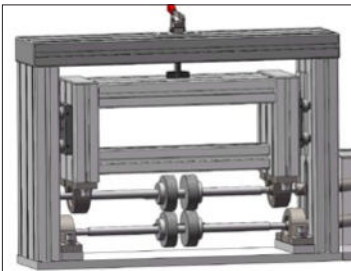

Vertical post 470 – 970 mm

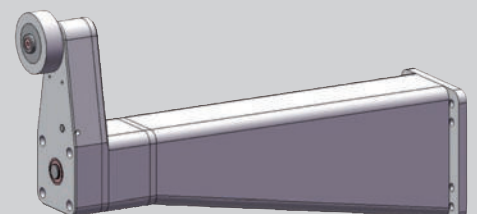

Versions:



Long-arm version



Long-arm version, with table, track rollers and puller



PFAFF 8320 FP  
Hot-air welding machine for closing filter pockets



PFAFF 8320-020/061  
Hot-air welding machine with adjustable tube guide

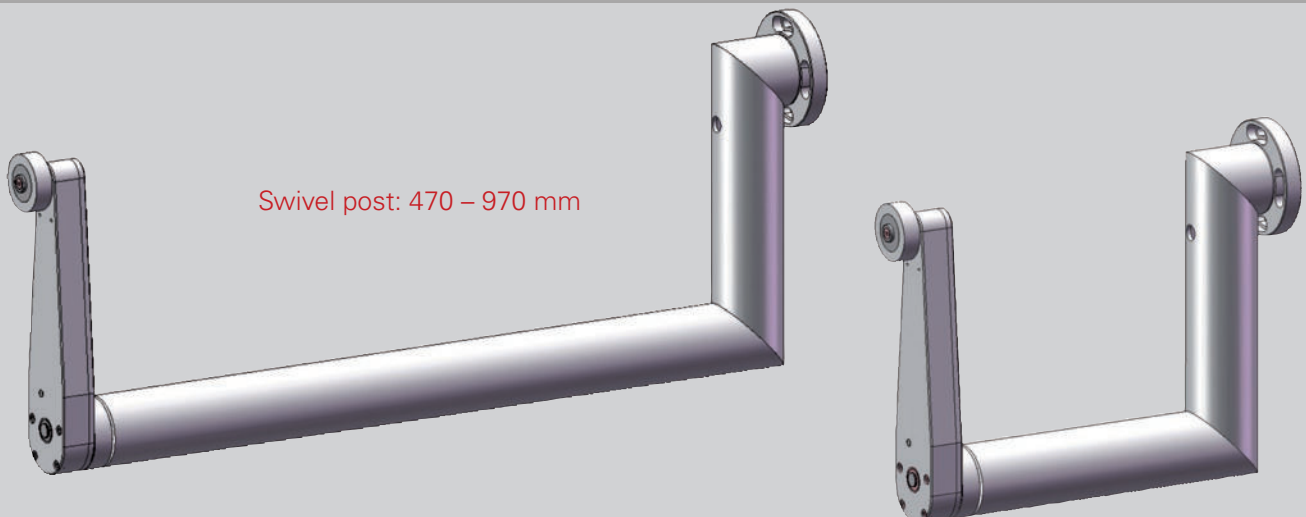

Swivel post: 470 – 970 mm

Further possible versions:

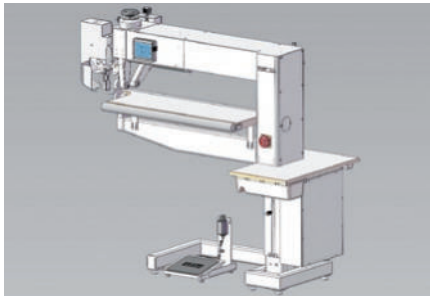

8320-1X1 Long-arm version with table, track rollers and puller

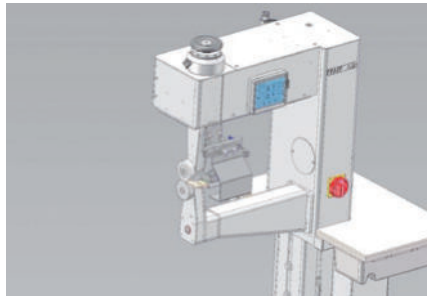

8320-0X1 Standard machine housing, vertical post, swinging unit from the right

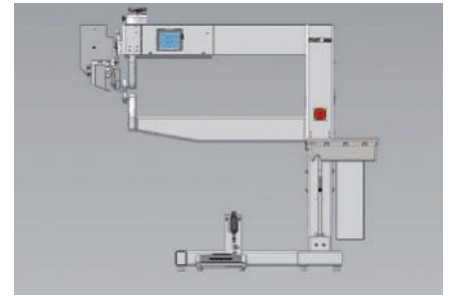

8320-1X1 Long-arm version, vertical post

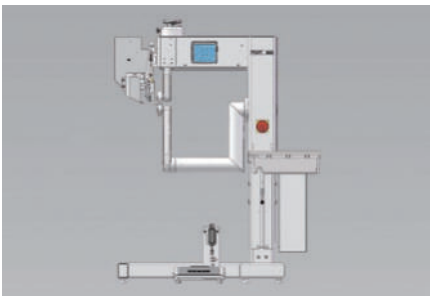

8320-0X0 Standard machine housing, swivel post

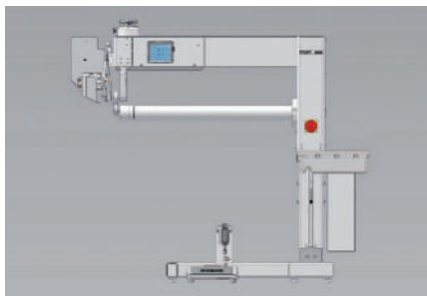

8320-1X2 Long-arm version, cylinder post

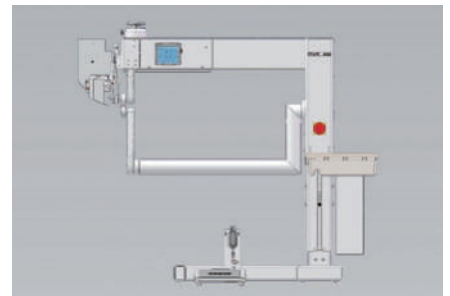

8320-1X0 Long-arm version, swivel post

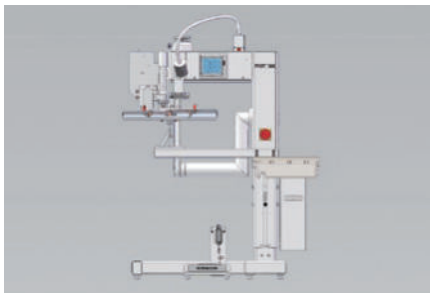

8320-020/061 Standard machine housing for filter tube production (hot-air)

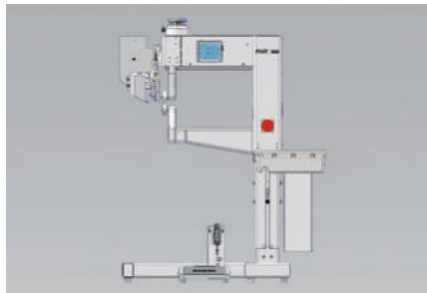

8320-0X1 Standard machine housing, vertical post

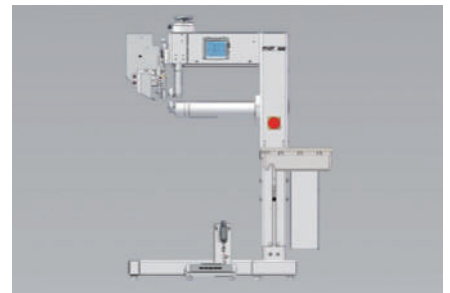

8320-0X2 Standard machine housing, cylinder post

All machines are available as hot-air or hot-wedge version (or both)  
X=1 hot-wedge, X=2 hot-air

## Technical Data:

### Dimensions and weight: (Basic machine)

Length: approx. 1650 mm / 1000 mm  
Width: approx. 700 mm  
Height: (without tape holder): approx. 1400 mm  
Clearance width: approx. 480 mm  
Clearance between rollers: approx. 20 mm

### Width of hot wedges (mm):

7, 9, 12, 15, 20, 30, 40

### Width of nozzles:

10 - 50 mm (others available)

### Net weight:

approx. 140 kg

### Sealing speed:

max. 10 m/min (standard)  
option up to 30 m/min available

### Mains voltage set for:

230 V  $\pm$  10%, 50/60 Hz, 1 phase

### Power input:

8320-010 (hot-wedge version): approx. 1500 W  
8320-020 (hot-air version): approx. 3500 W

### Heating capacity:

8320-010 (hot-wedge version): approx. 1000 W  
8320-020 (hot-air version): approx. 3300 W

### Air consumption (6 bar):

8320-010 (hot-wedge version): 30 l/min  
8320-020 (hot-air version): 30 – 150 l/min

### Sealing temperature:

8320-010 (hot-wedge version): max. 500°C  
8320-020 (hot-air version): max. 720°C

### Hotline:

Application support: +49-6301/3205-2329



### PFAFF Industriesysteme und Maschinen AG

Hans-Geiger-Str. 12 – IG Nord  
D-67661 Kaiserslautern

Telefon: +49-6301/3205-0  
Telefax: +49-6301/3205-3171  
E-mail: [info@pfaff-industrial.com](mailto:info@pfaff-industrial.com)

